

Code : YA-LS-2K-RA55-D

Product : SURFACE LINEAR SPOT 2W

LINEAR SPOT



- Precise light distribution with special configuration of optical system.
- Low UGR gives high visual comfort.
- Precise speckle with four kinds of beam angles : 10°/15°/30°/45°.
- Recessed miniaturised luminaire provides between size and light beam.
- Linear lighting fixture with perfect anti glare light distribution.
- Eccentric design makes precise speckle via reducing stray light.
- Radiant forging surface in die cast aluminum gives high heat efficiency.



TECHNICAL DATA :

<p>High Efficiency 70-100lm/w</p>	<p>Power 2W</p>	<p>CCT 2700K/3000K/4000K/6000K</p>
<p>LED Source Osram LED</p>	<p>CRI RA>90</p>	<p>High Lumens 140-150lm</p>
<p>Input Details 700mA / 3-8 VDC</p>	<p>Beam Angle 15°/30°/45°</p>	<p>Dimming Option SW/TD/DA</p>
<p>IP Rating IP20</p>	<p>Size H49*L65,CO-55*45mm</p>	<p>Weight 25gm ± 10%</p>
<p>MacAdam 3 Step</p>	<p>Finish White, Black</p>	<p>Refractor Lens White, Black</p>
<p>Temperature-Ambient Upto 40°C</p>	<p>Installation Recessed</p>	<p>Long Life Time 50,000 hrs</p>

DIMENSIONS :

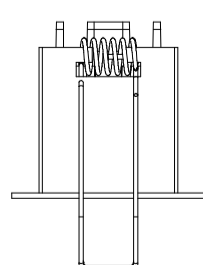
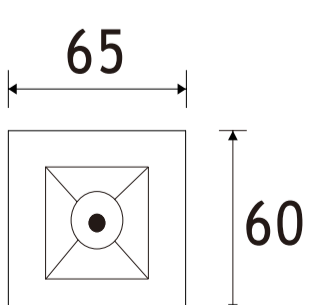

cut out:55x45

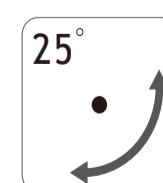
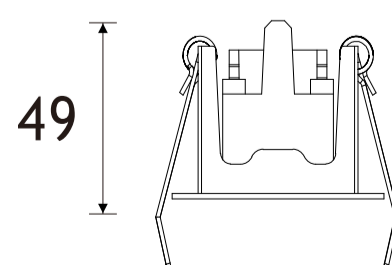

PHOTOMETRICS:

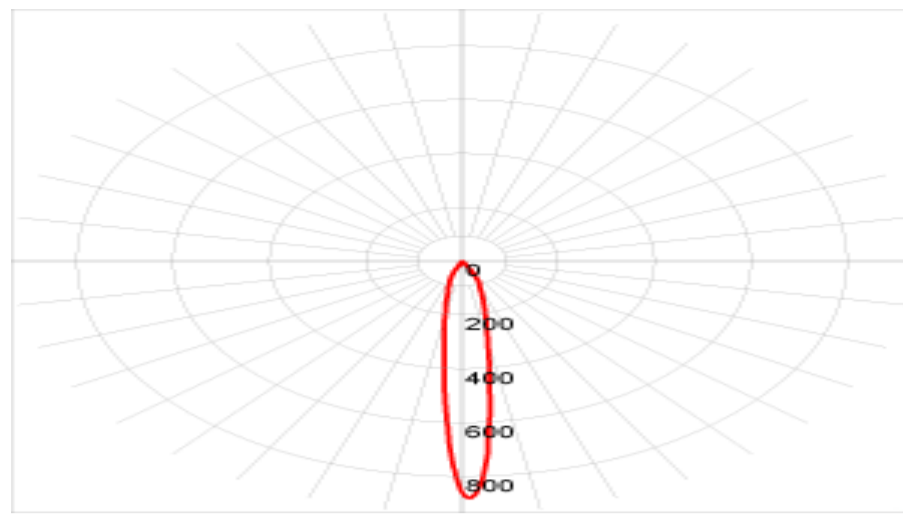

2W, 15D

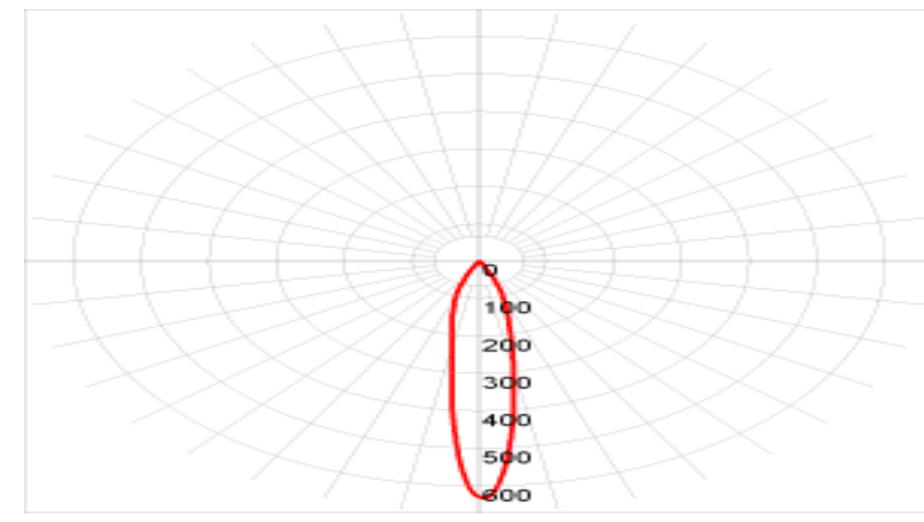

2W, 30D

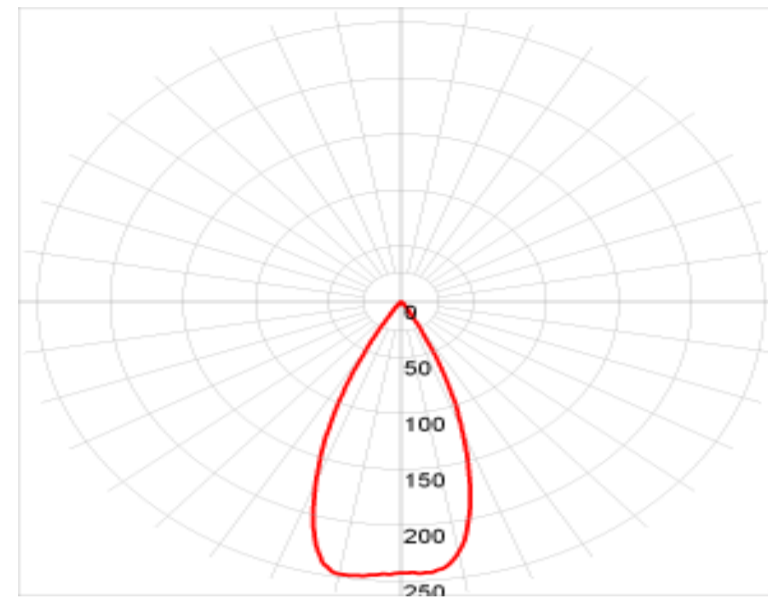

2W, 45D

ORDER INFORMATION :



Series

Linear Spot- LS



Wattage

W- 2, 4, 10, 20, 30



CCT

K- 3000, 4000, 6000



Mount

RA- Recessed Adjustable



Beam Angle

B- 15°/ 30°/45°



Finish Colours

White, Black

FRAMES :



White



Black