

Code : YA-DL-20K-R50-B

Product : LENN-I 10W\*2 300mA 34VDC

DOWNLIGHT



- Precise light distribution in three types : General Lighting, Washing and Accentuation.
- Modular design spot light system.
- Precise speckle with four kinds of beam angles : 15°/24°/36°/60°.
- Two kinds of optical assembly: Option glass / Honeycomb.
- Anti glare accessories for excellent visual comfort.
- Eccentric design makes precise speckle via reducing stray light.
- Straight heat sink design achieves high performance of heat dissipation and keep LED chip working in high lumens in long lifetime.

### TECHNICAL DATA :

<p><b>High Efficiency</b> 90-120lm/w</p>	<p><b>Power</b> 20W</p>	<p><b>CCT</b> 3000K / 4000K / 6000K</p>
<p><b>LED Source</b> Edison LED</p>	<p><b>CRI</b> RA&gt;85</p>	<p><b>High Lumens</b> 1800-2400lm</p>
<p><b>Input Details</b> 300mA / 34 VDC</p>	<p><b>Beam Angle</b> 15°/24°/36°/60°</p>	<p><b>Dimming Option</b> SW/TD/DA</p>
<p><b>IP Rating</b> IP20</p>	<p><b>Size</b> H85*L182*W94,CO-160*75mm</p>	<p><b>Weight</b> 220gm ±10%</p>
<p><b>MacAdam</b> 3 Step</p>	<p><b>Finish</b> White,Black</p>	<p><b>Low Height</b> From 70mm</p>
<p><b>Temperature-Ambient</b> Upto 40°C</p>	<p><b>Installation</b> Recessed</p>	<p><b>Long Life Time</b> 50,000 hrs</p>

### DIMENSIONS :

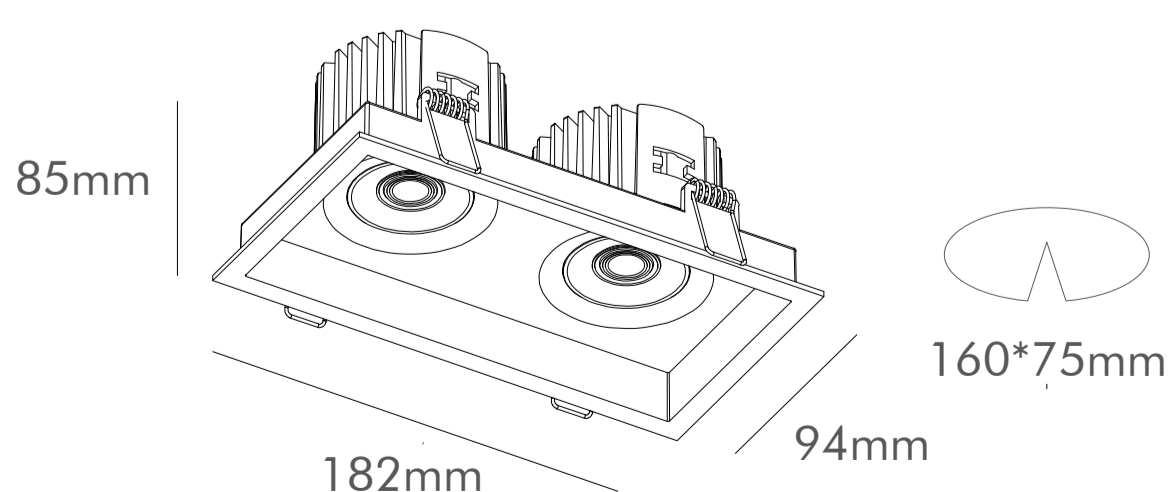

## PHOTOMETRICS:

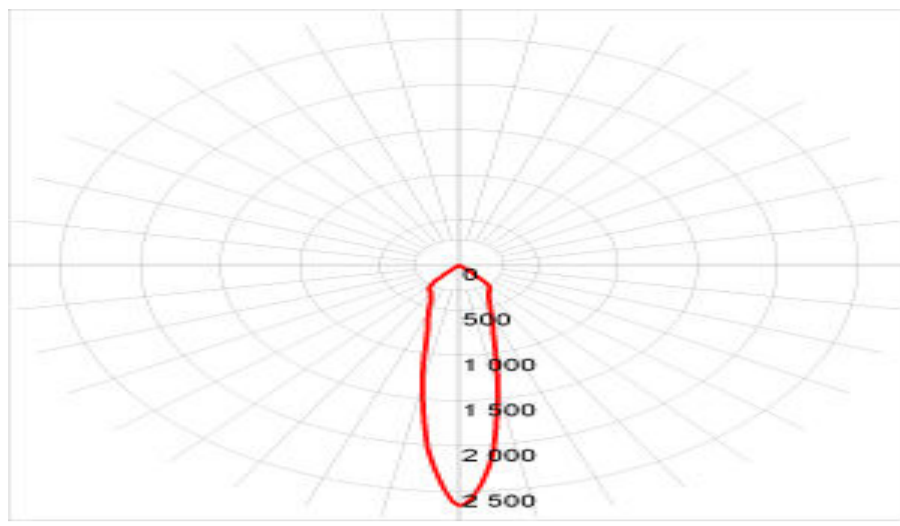

20W, 15D

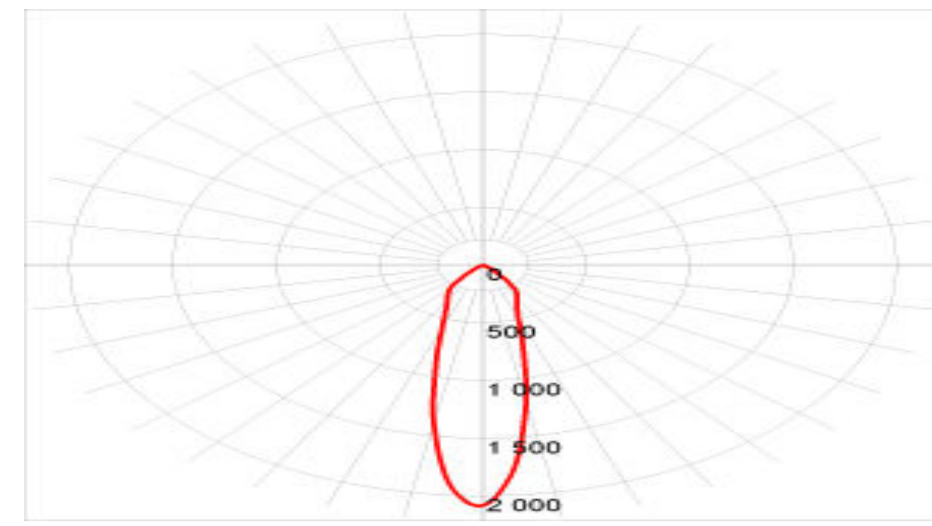

20W, 24D

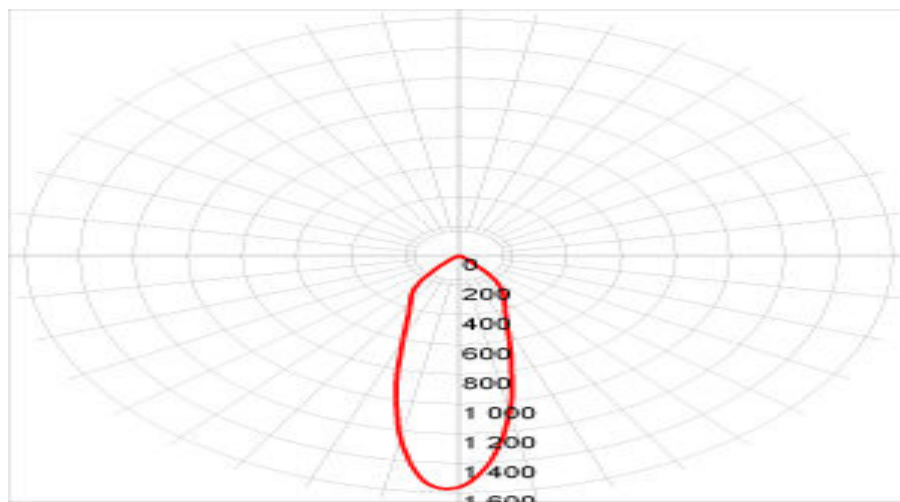

20W, 36D

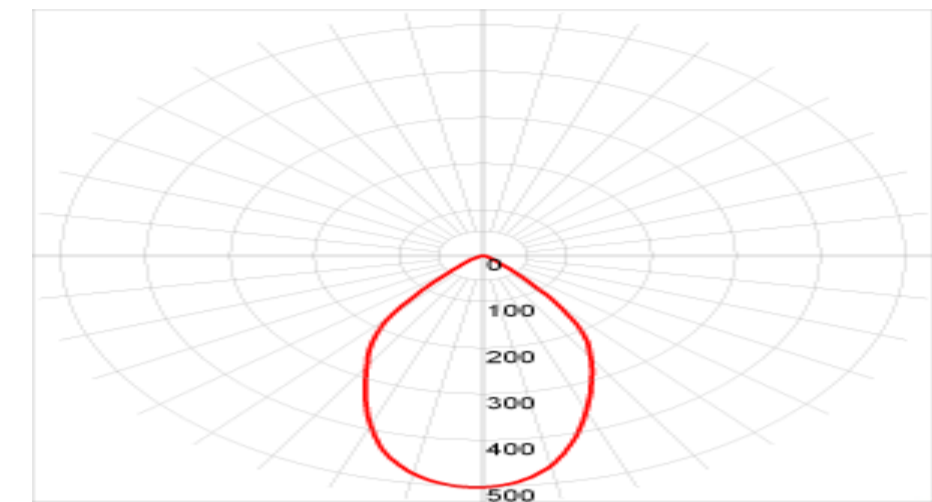

20W, 60D

## ORDER INFORMATION :



Series  
Lenn-I



Wattage  
W- 7,10,15



CCT  
K- 3000, 4000, 6000



Shape  
RD- Round Dimen, SD-Square Dimen

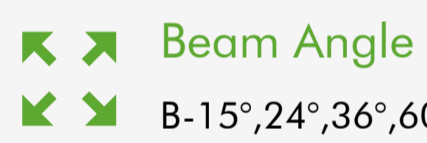

Beam Angle  
B-15°,24°,36°,60°

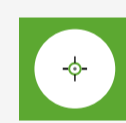

Optional Accessories  
HC-Honeycomb, Clear glass

## FRAMES :



F-DL-LB2-WW



F-DL-LB2-BB



F-DL-LB2-WB