

Code : YA-DL-15K-R50-B

Product : OSMO 15W 420mA 34VDC

DOWNLIGHT



- Precise light distribution in three types : General Lighting, Washing and Accentuation.
- Modular design spot light system.
- Precise speckle with four kinds of beam angles : 15°/24°/36°/60°.
- Two kinds of optical assembly: Option glass / Honeycomb.
- Anti glare accessories for excellent visual comfort.
- Eccentric design makes precise speckle via reducing stray light.
- Straight heat sink design achieves high performance of heat dissipation and keep LED chip working in high lumens in long lifetime.

TECHNICAL DATA :

<p>High Efficiency 90-120lm/w</p>	<p>Power 15W</p>	<p>CCT 3000K / 4000K / 6000K</p>
<p>LED Source Edison LED</p>	<p>CRI RA>85</p>	<p>High Lumens 1350-1800lm</p>
<p>Input Details 420mA / 34 VDC</p>	<p>Beam Angle 15°/24°/36°/60°</p>	<p>Dimming Option SW/TD/DA</p>
<p>IP Rating IP20</p>	<p>Size H132*D85,CO-75mm</p>	<p>Weight 180gm ±10%</p>
<p>MacAdam 3 Step</p>	<p>Finish White,Black</p>	<p>Low Height From 70mm</p>
<p>Temperature-Ambient Upto 40°C</p>	<p>Installation Recessed</p>	<p>Long Life Time 50,000 hrs</p>

DIMENSIONS :

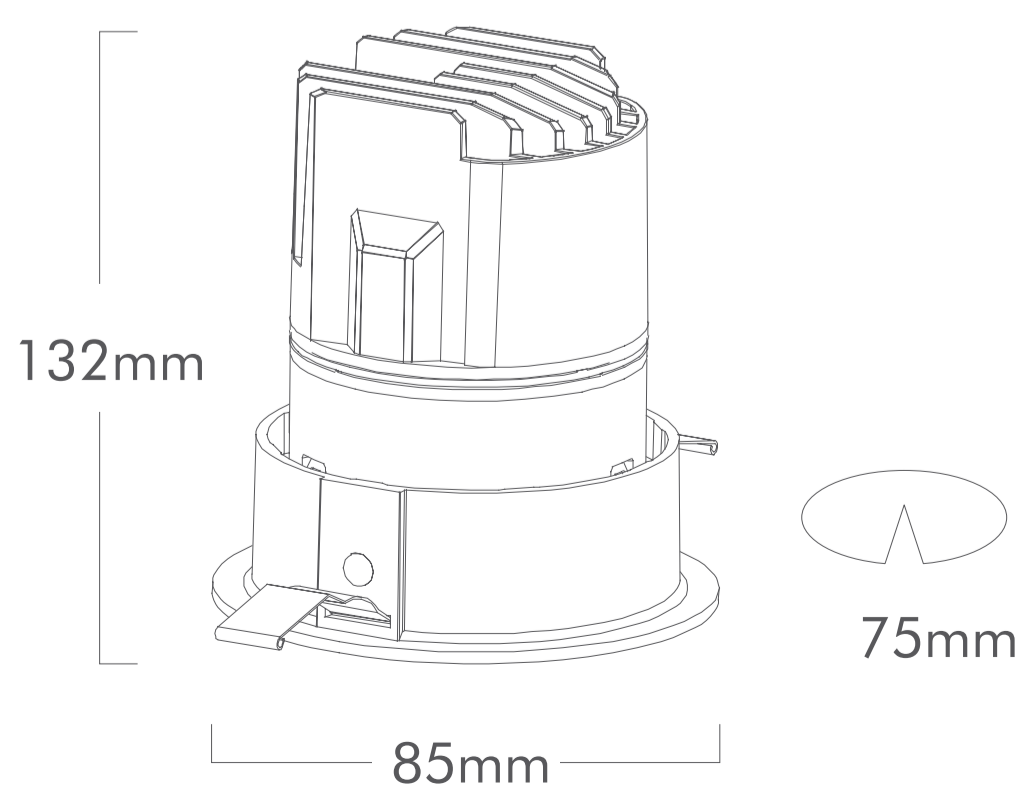

PHOTOMETRICS:

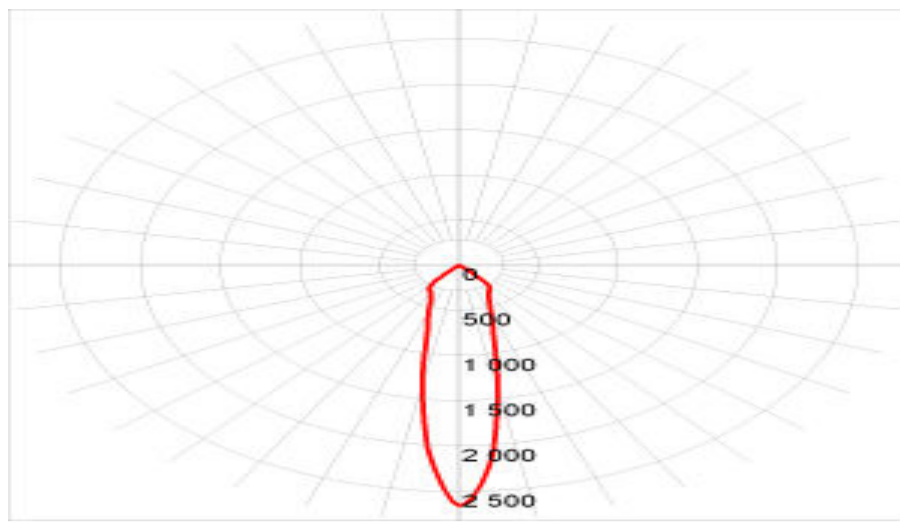

15W, 15D

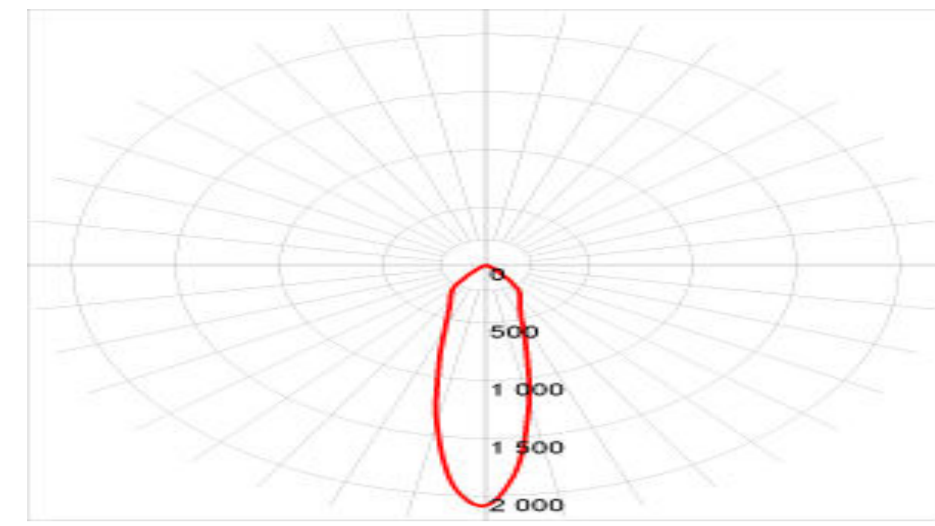

15W, 24D

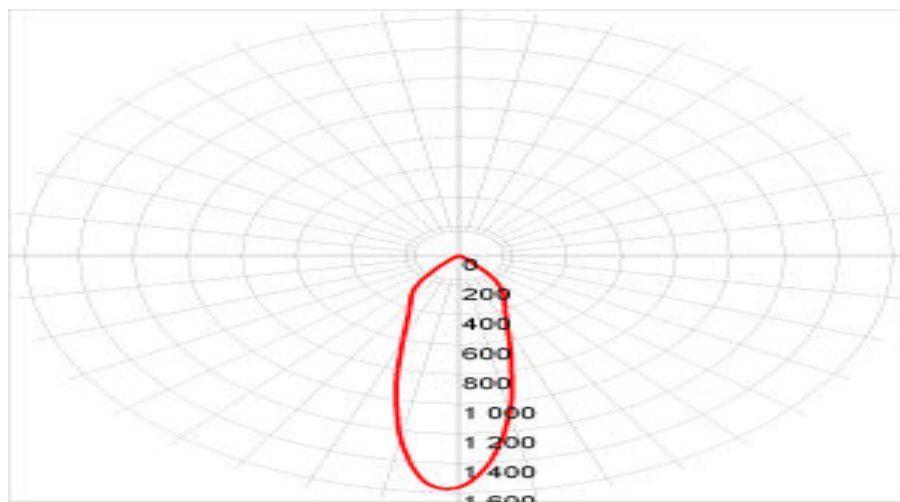

15W, 36D

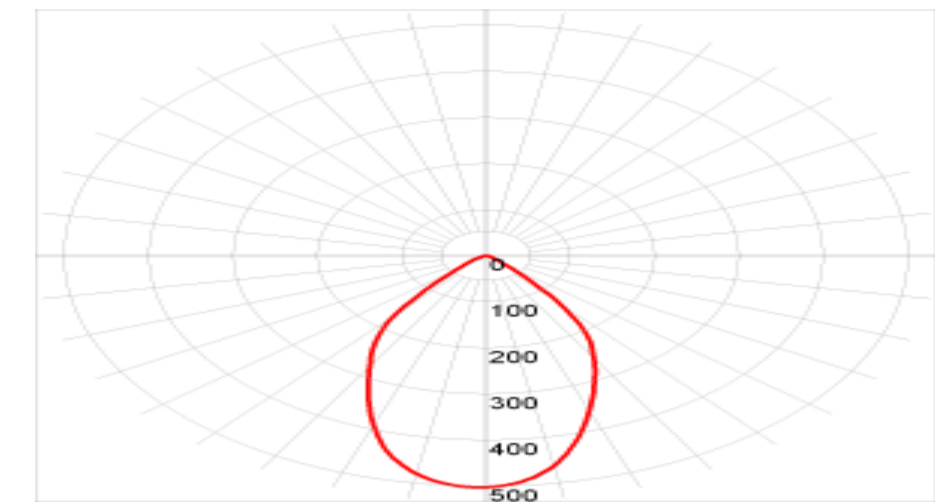

15W, 60D

ORDER INFORMATION :



Series
Osmo



Wattage
W- 7,10,15



CCT
K- 3000, 4000, 6000



Shape
RD- Round Dimen, SD-Square Dimen



Beam Angle
B-15°,24°,36°,60°



Optional Accessories
HC-Honeycomb, Clear glass

FRAMES :



F-R-15-WW



F-R-15-WB



F-R-15-BB